



LARGE-SCALE PRESENCE, FAMILY APPROACH



“BEHIND EACH OF OUR DOORS, THERE IS AN ORIGINAL IDEA, THE LATEST TECHNOLOGY, AND A TEAM THAT IS READY TO COMBINE THE STRENGTH OF STEEL WITH THE POWER OF DESIGN.”



DOOR SERIES	8
DOOR OPTIONS	15
DOOR MODELS	18
FRAMES	22
SPECIALTY FRAMES	25
FRAME OPTIONS	27
ELEVATIONS	28
SOLUTIONS	30
ACHIEVEMENTS	34

OUR AFFILIATIONS AND ACCREDITATIONS

- Steel Door Institute (SDI)
- Door & Hardware Institute (DHI)
- Construction Specification Institute (CSI)
- National Association of Architectural Metal Manufacturers (NAAMM)
- ISO 9001: 2015
- ITS Warnock Hersey
- AIA Provider



DE LA FONTAINE INDUSTRIES OFFERS A COMPLETE LINE OF HIGH QUALITY HOLLOW METAL DOORS AND FRAMES

BUILT WITH GALVANNEALED STEEL
OR STAINLESS STEEL. OUR COMPANY
EXPERTISE AND REPUTATION FOR
RELIABILITY IS BASED ON MORE THAN
50 YEARS OF EXPERIENCE IN THE STEEL
DOOR AND STEEL FRAME INDUSTRY.

DE LA FONTAINE FACTORIES

UNITED STATES

3 Normac RD
Woburn, MA 01801
T : 1 800 565-9230 ext.1410
T : 1 781 932-8663

3210 Hubbard Road
Hyattsville, MD 20785
T : 1 800 565-9230 ext.1710
T : 1 301 277-8044

901 Avenue M
Grand Prairie, TX 75050
T : 1 800 565-9230 ext.2210
T : 1 469 348-2272

1445 Brookville Way
Indianapolis, IN 46239
T : 1 800 565-9230 ext.1810
T : 1 317 802-7145

703 Pitts School Road NW
Suite C
Concord, NC 28027
T : 1 800 565-9230 ext.2010
T : 1 980 248-1059

5339 L B McLeod Road
Suite 900
Orlando, FL 32811
T : 1 800 565-9230 ext.2110
T : 1 321 710-9110

25 Genesco Parkway
Building A, Suite 100
Lebanon, TN 37090
T : 1 800 565-9230 ext.2310
T : 1 615 988-1990

3100 Ramco St
West Sacramento, CA 95691
T : 1-800-565-9230 ext.2410

Part of DE LA FONTAINE Group

4115 Brodeur Street
Sherbrooke, QC J1L 1K4
T : 1 800 565-9230
T : 1 819 821-9230
F : 1 819 569-5928

TO GET A QUOTE

quotes@delafontaine.com

READY TO PLACE AN ORDER?

orders@delafontaine.com

ANY QUESTIONS?

Contact our Customer service department
T : 1 800 565-9230 Option 1
customerservice@delafontaine.com

For quick ship orders, you may also communicate
directly with the manufacturing site. Please see
their respective phone numbers above.

ACCOUNTS RECEIVABLE AND CREDIT REFERENCES

receivables@delafontaine.com



DE LA FONTAINE

OUR FAMILY. YOUR SUCCESS.

HISTORICAL TIMELINE

1960

1968

Incorporation of DE LA FONTAINE in Sherbrooke (Quebec, Canada) by **Gérald de La Fontaine**. A visionary, he is the first in the Eastern Townships market to offer interior doors with pre-assembled frames.

1970

1973

The company moves to its current location on Brodeur Street, occupying 12,000 square feet.

1976

DE LA FONTAINE expands in Quebec thanks to several partnerships.

1980

1982

The second generation arrives on the scene as **Robert de La Fontaine succeeds his father**.

1986

The company expands its operations in the US: René Bouchard, previously responsible for sales, opens the first US warehouse in Hartford, CT.

1989

Mass production of the first steel door begins.

1990

1993

Steel is adopted for all door and frame production.

1995

Increased development in the US market is driven by a partnership with Smoot Associates, Inc.

1998

The “Toyota” management model and added-value production principles are adopted.

1999

The company is well established in the US Northeast. **France, Richard** and **Anie de La Fontaine** have all joined their brother Robert in investing in the family business.

OUR AMBITION

Our purpose goes beyond what we sell. We're using our business model to become the Americas leading quick-service manufacture of steel doors and frames.

OUR MISSION

To work beyond our doors to build an organization that provides peace of mind and outstanding service, one relationship at a time.

OUR VALUES

RESULTS-ORIENTED | TEAM SPIRIT | INTEGRITY | DEDICATION

<p>2000</p>	<p>2012</p> <p>The third generation joins the company: the arrival of Gabriel de La Fontaine brings new dreams, new ideas and new energy.</p>	<p>2019</p> <p>Acquisition of CMP Express in Grand Prairie TX. The DE LA FONTAINE family now include four factories and more than 275 employees.</p>
<p>2007</p> <p>Expansion of the Sherbrooke facility to accommodate a new prefinishing line. The factory now occupies 60,000 square feet.</p>	<p>2013</p> <p>Major investments in the Sherbrooke facility in order to support current and future growth at DE LA FONTAINE.</p>	<p>2020</p>
<p>2009</p> <p>Market launch of a line of prefinished products with flexible designs that combine performance and esthetics while maintaining fire-resistance standards.</p>	<p>2014</p> <p>Launch of Microsoft Dynamics AX 2012 integrated management software.</p>	<p>2021</p> <p>Installation of a fifth facility in Indianapolis, IN USA.</p>
<p>2010</p>	<p>2016</p> <p>Expansion of the Sherbrooke facility (20 000 square feet) to support our growth plan.</p>	<p>2022</p> <p>Installation of a sixth facility in Concord, NC USA.</p>
<p>2010</p> <p>Transformation of the Woburn, MA warehouse into a flexible factory.</p>	<p>2017</p> <p>Acquisition of Lindstrom Corporation in Hyattsville MD.</p>	<p>2023</p> <p>Installation of a seventh facility in Orlando, FL USA.</p> <p>Installation of a eighth facility in Lebanon, TN USA.</p>
<p>2011</p> <p>International development: the company's reputation gains notoriety in new markets (Middle East, Latin America, etc.).</p>	<p>2018</p> <p>Major investments in all of our facilities to improve our production capacity.</p>	<p>2024</p> <p>Installation of a eighth facility in West Sacramento, CA USA.</p>

QUALITY PRODUCTS, RELIABLE SERVICE, AND 3 WEEK DELIVERY*: THIS IS THE COMBINATION THAT MAKES US A TRUE PARTNER.

DE LA FONTAINE Industries offers a complete line of high quality hollow metal doors and frames built with galvanized steel or stainless steel. These are available as standard products as well as more complex or custom-designed products. You choose the options that suit your project, as each product is made to order according to YOUR NEEDS.

LEADTIME/SERVICE

WITHIN 3 WEEKS*:

Custom or standard galvanized hollow metal doors, frames (including split frames) and sidelites, including continuously welded products, primed or not.

WITHIN 4 WEEKS*:

Prefinished powder-coated hollow metal doors, frames and sidelites.

WITHIN 4 WEEKS*:

Stainless steel, lead-lined, and acoustical products, including continuously welded products.

* Larger or more complex projects may require additional time.

For more details, please call our customer service.

QUICK SHIP PROGRAM:

DE LA FONTAINE offer multiple quick ship programs to fulfill your needs. From a 1* day turbo, to 3-5* days Express to a 7-10* days fastlane.

*Completion time

QUALITY ASSURANCE

- **More than 50 years of experience as a manufacturer in the industry.**
- **Quality products manufactured with state-of-the-art equipment.**
- **Meeting or exceeding industry standards.**
- **ISO 9001: 2015 certified.**

MATERIAL

Our products are made with galvanized steel with a coating of a zinc-iron alloy. This alloy offers better corrosion resistance than primed cold-rolled steel and requires less surface preparation for painting than hot-dipped galvanized steel (G60-G90).

For interior openings, DE LA FONTAINE offers the A40 (ZF 120) designation; for exterior applications or wet areas, the A60 (ZF 180) designation is available.

DE LA FONTAINE also offers stainless steel 304 and 316, finish no.4 (satin finish) for environments in the presence of corrosive products or for wet areas.

STEEL COMPLIANCE

ASTM A653/A653M

Our galvanized steel complies with ASTM A653/A653M (Standard Specification for Steel Sheet, Zinc-Coated (Galvanized) or Zinc-Iron Alloy Coated (Galvanized) by the Hot Dip Process).

ASTM A240/A240M

Our stainless steel complies with ASTM A240/A240M (Standard Specification for Chromium and Chromium Nickel Stainless Steel Plate, Sheet and Strip for Pressure Vessels and for General Applications).

STEEL GAUGES

For quality purposes, our steel gauges exceed industry standard ANSI/SDI A250.8.

FIRE RATING

The basic requirements and limitations regarding DE LA FONTAINE fire doors and frames are defined by the National Fire Protection Association, NFPA 80 (Standard for Fire Doors and Other Opening Protectives).

Our products also comply with the following standards:

- **UL 10C** (Standard Positive Pressure Fire Tests of Door Assemblies)
- **NFPA 252** (Standard Methods of Fire Tests of Door Assemblies)
- **NFPA 257** (Standard on Fire Test of Window and Glass Block Assemblies)
- **CAN/ULC S104** - Standard Method for Fire Tests of Door Assemblies
- **CAN/ULC S106** - Standard Method for Fire Tests of Window and Glass

DE LA FONTAINE performs its fire testing at Intertek Testing Services (ITS/Warnock Hersey) to receive approval and obtain listing, labeling, and follow-up services for the fire-rated products we manufacture¹.

¹ For additional information on fire-rated doors and frames manufactured by DE LA FONTAINE, contact your Sales Representative or our Customer service team.



ECOLOGICAL RESPONSIBILITY

DE LA FONTAINE Industries has adopted ecological principles aimed to consume less, pollute little and recycle more. Here are some examples of our commitments:

- Contribution of our products to the LEED v4 certification
- 100% recycling of steel waste
- Recycling of production waste
- Recycling of wood transport pallets

Our Environmental Product Declarations (EPD) and chemical ingredient disclosure report for our products demonstrate how they are designed and manufactured. This commitment to transparency meets the most recent requirements for sustainable buildings.

Please contact the Customer service for any LEED-related information.

PRIMER AND PAINT

Our galvanized steel is suitable for immediate painting, although we also offer water-based primed products and factory prefinished products using a durable powder-coating process.

PRIMER

- Our baked-on primer improves protection against humidity and corrosion and can be covered with any type of coating.
- Water-based, it complies with current environmental standards due to its low VOC content.
- > **Our primer exceeds ANSI standard A250.10 (Test Procedures and Acceptance Criteria for Factory Applied Finish Painted on Steel Surfaces for Steel Doors and Frames).**

PAINT

- Powder-coated paint is available for many of our products. Our standard color palette includes several colors and can be complemented by custom colors as needed. Please consult our "Paint" technical data sheet on our website for more information.
- Powder-coated paint:
 - Offers durability and a quality finish
 - Reduces coordination on jobsite
 - Does not contain any solvents or VOCs (volatile organic compounds)
- > **Exceeds ANSI standard A250.3 (Test Procedures and Acceptance Criteria for Factory Applied Finish Painted on Steel Surfaces for Steel Doors and Frames).**

RECYCLED CONTENT

The total recycled content of our **galvanized steel** is approximately 89.7%.

This includes:

- A total post-consumer content of 50.6%
- A total post-industrial content of 33.3%
- The remaining 5.8% is comprised of home scrap.

The total recycled content of our **stainless steel** is over 85%. However, the mill makes no distinction as to the origin of the scrap.

HC SERIES

HONEYCOMB CORE

KEY FEATURES

- 1" (25.4 mm) hexagonal cell Kraft paper core
- Excellent crushing strength
- 1 3/4" door thickness only
- Edge seam options:
 - Lock seam (PA) 20-, 18- or 16-gauge
 - Lock seam and filled (PAF) 20-, 18- or 16-gauge
 - Continuously welded seamless edge (CW) 18-, 16- and 14-gauge

Performance

- PA18 : 1,000,000 cycles (Class A) per ANSI/SDI A250.4

Fire Rating

- Available up to 3 hours with ITS/WHI label. Limitations apply.

Windstorm Rating

- FL#46851, ±70 PSF, HVHZ, Large Missile Impact D. Available Outswing and Inswing. Limitations apply.

STANDARD FEATURES

- A40 galvanized material
- 16-gauge top and bottom welded inverted channel
- Both edges beveled 1/8" in 2"

OPTIONS

- A60 or G90 material
- Flush or sealed top and bottom welded channel
- Primer for A40 and A60
- Factory prefinishing - powder coat only

HARDWARE REINFORCEMENTS

- Hinges: 7-gauge
- Closer: Available in 16-gauge, 14-gauge and 12-gauge
- Locks: 12-gauge



PS SERIES

POLYSTYRENE CORE

KEY FEATURES

- Interior and exterior usage
- Expanded polystyrene core
- 1 3/4" door thickness standard (available 1 3/8" to 2 1/4")
- Edge seam options:
 - Lock seam (PA) 20-, 18- or 16-gauge
 - Lock seam and filled (PAF) 20-, 18- or 16-gauge
 - Continuously welded seamless edge (CW) 18-, 16-, 14- and 12-gauge
- Thermal performance
[R - ft²·°F·h/BTU (m²·K/W); U - BTU/ft²·°F·h (W/m²·K)]
 - R2.50 (0.44) - U 0.37 (2.27) per SDI-113 (ASTM C1199, C1363, E1423)

Performance

- PA18 : 1,000,000 cycles (Class A) per ANSI/SDI A250.4
- CW16 : 6,000,000 cycles (Class A) per ANSI/SDI A250.4

Fire Rating

- Available up to 3 hours with ITS/WHI label. Limitations apply.

Windstorm Rating

- FL#46851, ±70 PSF, HVHZ, Large Missile Impact D. Available Outswing and Inswing. Limitations apply.

STANDARD FEATURES

- A40 galvanized material
- 16-gauge top and bottom welded inverted channel

OPTIONS

- A60 or G90 material
- Flush or sealed top and bottom welded channel
- Primer for A40 and A60
- Factory prefinishing **not available**

HARDWARE REINFORCEMENTS

- Hinges: 7-gauge
- Closer: Available in 16-gauge, 14-gauge and 12-gauge
- Locks: 12-gauge



PU SERIES

POLYURETHANE CORE

KEY FEATURES

- Mostly exterior usage
- Polyisocyanurate (polyurethane) core
- 1 3/4" door thickness only
- Edge seam options:
 - Lock seam (PA) 20-, 18- or 16-gauge
 - Lock seam and filled (PAF) 20-, 18- or 16-gauge
 - Continuously welded seamless edge (CW) 18-, 16- and 14- gauge
- Thermal performance
 - 1.84 W/m²·K (0.32 BTU/hr·ft²·°F) with thermal brake frame
 - 1.99 W/m²·K (0.35 BTU/hr·ft²·°F) with standard frame

Fire Rating

- Available up to 3 hours with ITS/WHI label. Limitations apply.

Windstorm Rating

- FL#46851, ±70 PSF, HVHZ, Large Missile Impact D. Available Outswing and Inswing. Limitations apply.

STANDARD FEATURES

- A40 galvanized material
- 16-gauge top and bottom welded inverted channel

OPTIONS

- A60 or G90 material
- Flush or sealed top and bottom welded channel
- Primer for A40 and A60
- Factory prefinishing **not available**

HARDWARE REINFORCEMENTS

- Hinges: 7-gauge
- Closer: Available in 16-gauge, 14-gauge and 12-gauge
- Locks: 12-gauge



ST SERIES

STEEL STIFFENED CORE

KEY FEATURES

- Increased durability and security
- Interior and exterior usage
- Bonded 18-gauge steel stiffeners 6" o.c. with industrial adhesive ensuring a smooth and aesthetic surface (laser welds optional)
- Voids between stiffeners filled with:
 - Polystyrene, all door thickness available (Default option)
 - Polyurethane, 1-3/4" door thickness only
 - Mineral wool, 1-3/4" and 2" door thickness available
- Edge seam options:
 - Lock seam (PA) 18- or 16-gauge
 - Lock seam and filled (PAF) 18- or 16-gauge
 - Continuously welded seamless edge (CW) 18-, 16-, 14- and 12-gauge
- Thermal performance
[R - ft²·°F·h/BTU (m²·K/W); U - BTU/ft²·°F·h (W/m²·K)]
 - STPS: R1.89 (0.33) - U 0.53 (3.00) per SDI-113 (ASTM C1199, C1363, E1423)
 - STPU: R1.96 (0.34) - U 0.51 (2.90) per SDI-113 (ASTM C1199, C1363, E1423)
 - STW: R1.47 (0.26) - U 0.68 (3.86) per SDI-113 (ASTM C1199, C1363, E1423)

Fire Rating

- Available up to 3 hours with ITS/WHI label. Limitations apply.

Windstorm Rating

- FL#46851, ±70 PSF, HVHZ, Large Missile Impact D. Available Outswing and Inswing. Limitations apply.

STANDARD FEATURES

- A40 galvanized material
- 16-gauge top and bottom welded inverted channel

OPTIONS

- A60 galvanized material
- Flush or sealed top and bottom welded channel
- Laser welded stiffeners (**Mineral wool only**)
- Primer for A40 and A60
- Factory prefinishing - powder coat (**Mineral wool only**)

HARDWARE REINFORCEMENTS

- Hinges: 7-gauge
- Closer: Available in 16-gauge, 14-gauge and 12-gauge
- Locks: 12-gauge



TR SERIES

TEMPERATURE RISE CORE

KEY FEATURES

- Additional protection against heat on the unexposed side
- Mostly for doors in the path of egress
- Two core types available:
 - Solid mineral slab
 - Steel stiffened with mineral wool
- 1 3/4" door thickness only
- Edge seam options:
 - Lock seam (PA) 18- or 16-gauge
 - Lock seam and putty filled (PAF) 18- or 16-gauge
 - Continuously welded seamless edge (CW) 18-, 16-, 14-gauge

Performance

- 250°F in 30 minutes (mineral slab)
- 450°F in 30 minutes (mineral slab)
- 450°F in 30 minutes (steel stiffened with mineral wool)

Fire Rating

- Available up to 3 hours with ITS/WHI label. Limitations apply.

STANDARD FEATURES

- A40 Galvannealed material

OPTIONS

- A60 or G90 material
- Primer for A40 and A60
- Factory prefinishing – powder coat (mineral wool only)

HARDWARE REINFORCEMENTS

- Hinges: 7-gauge
- Closer: Available in 16-gauge, 14-gauge and 12-gauge
- Locks: 12-gauge



STC SERIES

ACOUSTICAL CORE

KEY FEATURES

- Ensures both sound reduction and privacy
- Proprietary core
- Opening size up to 4'0" x 8'0"
- Edge seam options:
 - Lock seam (PA) 18-gauge or 16-gauge (STC48)
 - Lock seam and filled seamless (PAF) 18-gauge or 16-gauge (STC48)

Performance

- Tested to ASTM E90, E413, E1332, E2235 Standards
- Operable door frame and gasketing achieved STC up to 48. Assembly includes door, frame and acoustical gasketing items.
- Pairs of doors have not been tested

STANDARD FEATURES

- A40 galvanized material
- 16-gauge standard or flush and welded top and bottom channels (depending on STC, consult Technical Data Book).

OPTIONS

- A60 or G90 material
- Primer for A40 and A60

HARDWARE REINFORCEMENTS

- Hinges: 7-gauge hinge reinforcements
- Closer: Available in 16-gauge, 14-gauge and 12-gauge
- Locks: 12-gauge

Included hardware (depending on STC, consult Technical Data Book).



DOOR SERIES - STC
ACOUSTICAL CORE

LL SERIES

LEAD LINED CORE

KEY FEATURES

- For use in environments where radiation is present
- Expanded polystyrene core with 98% pure lead sheet available in two different thicknesses:
 - 1/16"
 - 1/8" (16-, 14- and 12-gauge door only)
- Door thickness from 1 3/4" up to 2 1/4"
- Edge seam options:
 - Lock seam (PA) 18- or 16-gauge
 - Lock seam and putty filled (PAF) 18- or 16-gauge
 - Continuously welded seamless edge (CW) 18-, 16-, 14- and 12-gauge

Complies with:

- ASTM B29: Standard Specification for Refined Lead
- Federal Specification QQ-L-201 "C" Category
- CSA HP2 type 2 lead

STANDARD FEATURES

- A40 galvanized material
- 16-gauge flush and welded top and bottom cap

OPTIONS

- A60 or G90 material
- Primer for A40 and A60
- Factory prefinishing **not available**

HARDWARE REINFORCEMENTS

- Hanging: We recommend using pivot sets.
- Closer: Available in 16-gauge, 14-gauge and 12-gauge
- Locks: 12-gauge

NOTE: DE LA FONTAINE WILL NOT DETERMINE THE NECESSARY LEAD THICKNESS.

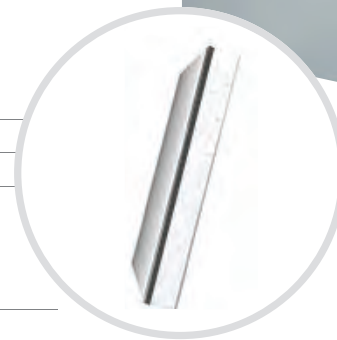

DOOR OPTIONS: **DOOR SEAMS**



Seamless, lock seam on edge construction.

- The seam is filled with industrial adhesive then filled and ground smooth (PAF).



Standard, lock seam on edge construction.

- Reinforced welded corners (PA).

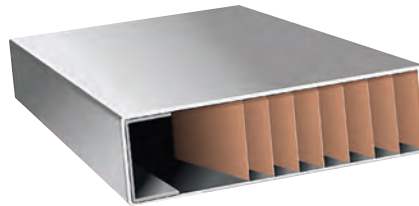

Seamless, continuously welded, internally reinforced stiles, 18-gauge (0.044"/1.1 mm) or 16-gauge (0.056"/1.4 mm).

- **Fully welded** centered seam, (CW).

DOOR OPTIONS: **DOOR EDGES**



Square edge door, 90-degree angle to the door face.

- Standard on strike edge of inactive door and hinge edge of door with continuous hinge.

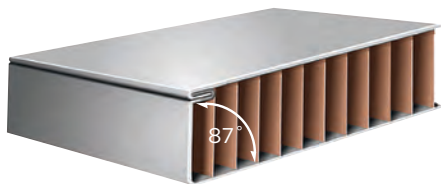

Beveled edge door, 87-degree angle to the door face (1/8" (3.2 mm) in 2" (50.8 mm)).

- Standard on active door or single leaf door.



Segmented radius edge for double acting door.

- The seam is filled with industrial adhesive then filled and ground smooth.
- Available in PAF series only.

DOOR OPTIONS: **TOP AND BOTTOM CHANNELS**

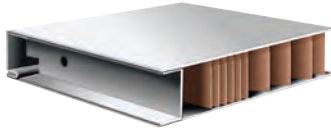

Standard, inverted steel channels, projection welded, 16-gauge (0.056"/1.4 mm) or 14-gauge (0.071"/1.8 mm).

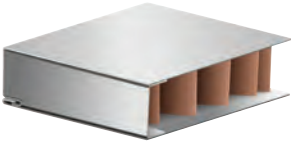

Flush steel channels, projection welded, 16-gauge (0.056"/1.4 mm), 14-gauge (0.071"/1.8 mm) or 12-gauge (0.105"/2.7 mm), not sealed.

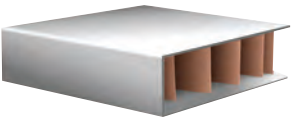

Flush and sealed steel channels, projection welded, 16-gauge (0.056"/1.4 mm), 14-gauge (0.071"/1.8 mm) or 12-gauge (0.105"/2.7 mm).

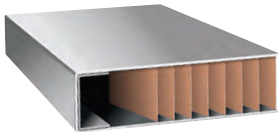

Fully continuously welded centered seam. Flush internal steel channels, 16-gauge (0.056"/1.4 mm) or 14-gauge (0.071"/1.8 mm). Stainless steel only



PVC top cap (snap-in). Sold as part only.

DOOR OPTIONS: **STANDARD DOOR HARDWARE REINFORCEMENTS**



hinge reinforcement, 7-gauge (0.167"/4.2 mm) flat hinge reinforcement.



Cylindrical lock reinforcement, 16-gauge* (0.056"/1.9 mm) lock front, 18-gauge (0.044"/1.1 mm) spacer.



Mortise lock reinforcement, 12-gauge (0.105"/2.7 mm) lock front, 16-gauge (0.056"/1.4 mm) box.



Flush bolt reinforcement, 12-gauge (0.105"/2.7 mm) tabs.



Standard ANSI 4 7/8" (123.8 mm) strike reinforcement, 16-gauge* (0.056"/1.4 mm).

* 12-gauge equivalent, as per ANSI A250.6 section 1.3.1 on equivalent treads rendered in a lighter gauge with pierced and dimpled hole.

NOTE: HARDWARE REINFORCEMENTS ARE PROJECTION WELDED. PLEASE CONTACT YOUR LOCAL REPRESENTATIVE FOR ADDITIONAL DETAILS ON HARDWARE REINFORCEMENT.

DOOR OPTIONS: VISION KITS AND LOUVERS



Standard two-part sandwich-type louver, inverted “Y” blades, welded corners, 50% free-flow area, 18-gauge (0.044”/1.1 mm).



Standard two-part sandwich-type vision kit, welded corner sections, 18-gauge (0.044”/1.1 mm). Available for 1/4” (6.3 mm) to 1” (25.4 mm) thick glass (SK series).



Two-part sandwich-type vision kit with muntins, 18-gauge (0.044”/1.1 mm). Only available non-rated and for 1/4” (6.3 mm) and 1/2” (13 mm) thick glass.



DLF flush vision kit, 16-gauge (0.056”/1.4 mm). Laser welded, available for 1/4” (6.3 mm) to 1” (25.4 mm) thick glass (FK series).



DLF flush seamless vision kit, 16-gauge (0.056”/1.4 mm). Laser welded, available for 1/4” (6.3 mm) to 1” (25.4 mm) thick glass (FKS series).

TYPICAL DOOR ELEVATIONS

Multiple sizes and combinations available with different door series or door models. Please consult factory for additional information.

We recommend keeping 7” (178 mm) stiles and 8” (203 mm) top rail to avoid any hardware conflicts. We also recommend keeping 6” (152 mm) middle rail and 10” (254 mm) bottom rail for door integrity.



NL:
Narrow lite



HG:
Half glass



2G:
Double
half glass



FG:
Full glass

EMB - DOOR MODELS PRE-EMBOSSSED

For classic elegance and an economical solution, choose from our pre-embossed panel doors.

AVAILABLE IN THE FOLLOWING DOOR SERIES:

- Polystyrene

KEY FEATURES

- 18-gauge
- A40 galvaneal steel only
- Fire ratings available up to 3 hours.
- Complies with the American National Standards Institute ANSI/SDI A250.4 standard
- Factory powder coat prefinishing available under special request. Please inquire.

Please consult our Technical Data Book for panel size limitations.



1PNL



2PNL



2PNLA



FL2PNL



4PNL



6PNL

CED - DOOR MODELS

CUSTOM EMBOSSED

This line brings together the strength of steel with the flexibility of the latest technology in order to personalize the design of doors. For a contemporary look, draw the lines, curves and panels yourself to enrich the perspectives of your project with a unique touch.

AVAILABLE IN ALL OF OUR DOOR SERIES

- 18- or 16-gauge
- A40, A60 galvanized steel or 304 and 316 stainless steel no. 4 satin finish
- Complies with the American National Standards Institute ANSI/SDI A250.4 standard
- Factory powder coat prefinishing available depending on door series.

EMBOSSING GROOVE STYLE AVAILABLE

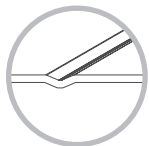

V MODEL

Most popular models

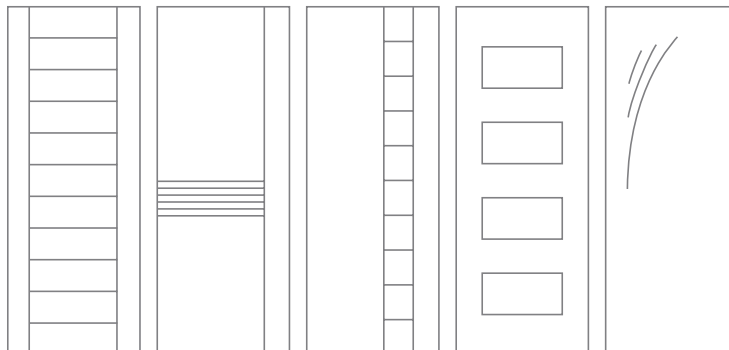

CED101

CED102

CED103

CED104

CED105

DOOR MODELS - CED
CUSTOM EMBOSSED

RPD - DOOR MODELS

RECESSED PANELS

Decide on the number of panels to embed as well as their size, add an aluminum molding to accent the relief and choose the prefinishing color. You will have a unique door—a steel door which respects the most demanding of performance standards and is resistant to fire, and a designer door which will harmoniously integrate into your project.

AVAILABLE IN THE FOLLOWING DOOR SERIES:

- Honeycomb
- Polystyrene

KEY FEATURES

- 18-, 16- or 14-gauge
- A40, A60 galvanized steel
- Fire ratings available up to 1-1/2 hours
- Complies with the American National Standards Institute ANSI/SDI A250.4 standard
- Factory powder coat prefinishing available for Honeycomb core only.



PANEL DESIGNS AVAILABLE



SHAKER
STYLE
RECESSED
PANEL



RECESSED
PANEL WITH
QUARTER
ROUND
MOLDING



RECESSED
PANEL WITH
PROFILE
MOLDING

Most popular models



RPD 101



RPD 102



RPD 103



RPD 104



RPD 105

Here are a few applications available for the Recessed Panel doors.

OUTDOOR APPLICATIONS

RPD with aluminum molding



INDOOR APPLICATIONS

Complete opening with LR frame with wood molding and RPD with aluminum molding with factory finish powder coat paint



OTHER APPLICATIONS

Shaker style RPD panel



SR SERIES STANDARD FRAME

Mostly used in masonry conditions

- Face welded or continuously welded frame assembly.
- Solid three-sided frame application.
- Available knock-down (KD), but compression anchor must be specified by customer if needed.
- **Available for drywall, but we recommend using the DR series.**

FIRE RATING

- Available up to 3 hours with ITS/WHI label. Limitations apply.

WINDSTORM RATING

- FL#46851, ±70 PSF, HVHZ, Large Missile Impact D. Available Outswing and Inswing. Limitations apply.

STANDARD FEATURES

- A40 galvanized steel
- 16-gauge steel

OPTIONS

- A60 and G90 material
- 18-, 14- and 12-gauge
- Primer for A40 and A60

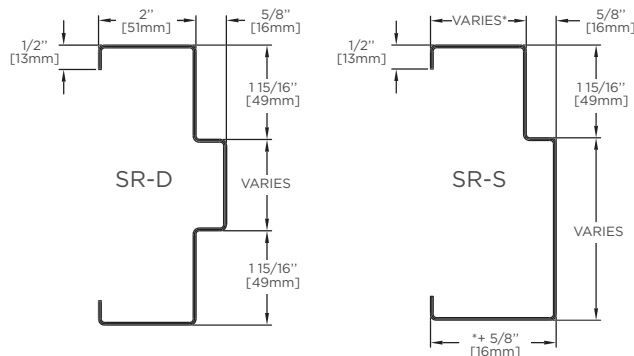

Standard Frame Anchors

DE LA FONTAINE standard anchors are designed for use in almost any job conditions. Custom anchors available.

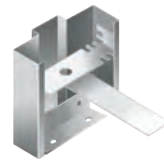

"T" masonry anchor (TMA) shipped loose. Includes floor anchors



Wire masonry anchor (WMA), shipped loose. Includes Floor anchors



Existing wall anchor (EWA) with reinforcement, welded.



Steel stud "Z" bracket anchor (ZBA), welded. Includes Floor anchors



Wood stud anchor (DCA), welded. Includes Floor anchors



Multi-purpose wood or steel stud anchor (SWS), 2-piece, shipped loose. Includes Floor anchors

Standard Frame Hardware Reinforcements



ANSI 4-7/8" strike reinforcement (16-gauge*).



Standard (0.134") or heavyweight (0.180") hinge reinforcement (7-gauge).

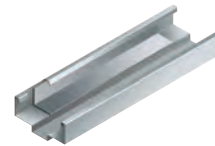

Regular arm closer reinforcement (12-gauge).



Parallel arm closer reinforcement (12-gauge).

* 12-gauge equivalent, as per ANSI A250.6 section 1.3.1 on equivalent treads rendered in a lighter gauge with pierced and dimpled hole.

DR SERIES PRE-DRYWALL FRAME

Designed to be installed into metal or wood stud framing before drywall board is installed.

- Face welded or continuously welded drywall three-sided frame.
- 18-gauge welded-in steel stud anchors (standard).
- 16-gauge welded floor anchor (standard).
- Wood stud anchor (optional).
- Multi-purpose anchor (optional), shipped loose.

FIRE RATING

- Available up to 3 hours with ITS/WHI label. Limitations apply.

WINDSTORM RATING

- FL#46851, ± 70 PSF, HVHZ, Large Missile Impact D. Available Outswing and Inswing. Limitations apply.

STANDARD FEATURES

- A40 galvanized steel
- 16-gauge steel

OPTIONS

- A60 and G90 material
- 18- and 14-gauge
- Primer for A40 and A60

Continuously
Welded Frame



Face Welded
Frame



Note: This is an example. Other options are available. Please contact customer service for details.

DW SERIES DRYWALL FRAME

Designed to be installed after the wall is up (slip-on 3-piece frame).

- Three-sided frame for drywall applications.
- KD assembly.
- Compression anchor (leveling screw) at the top of each jamb for plumbness and level
- Frame face prepared for no 6 drywall screw (standard) (SBA).
- Drywall strap anchors (optional) (DSA).



Screw base anchor



Drywall strap anchor (DSA).

FIRE RATING

- Available up to 3 hours with ITS/WHI label. Limitations apply.



Knock-down (KD) assembly with tabs and compression anchor.



Knock-down (KDS) assembly with screws and compression anchor.

WINDSTORM RATING

- FL#46851, ±70 PSF, HVHZ, Large Missile Impact D. Available Outswing and Inswing. Limitations apply.

STANDARD FEATURES

- A40 galvanized steel
- 16-gauge steel

OPTIONS

- A60 and G90 material
- 18- and 14-gauge
- Primer for A40 and A60

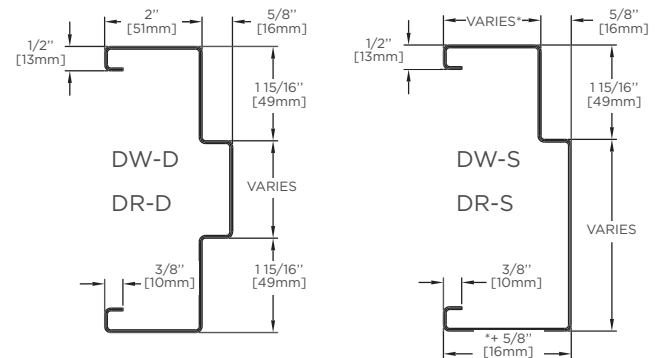

LR SERIES

LESS RETURN FRAME

Designed for wood trim nailed on the perimeter (wood trim prep).

- Ideal for historic renovations, elderly housing or nursing homes.
- Warm-feeling, true commercial frame.
- High-end and affordable three-sided frame for drywall applications.
- The ideal application is KD.
- Available in face welded or split frame configuration.
- Wall thickness is critical when ordering this frame.

FIRE RATING

- Available up to 1 ½ hour with ITS/WHI label. Limitations apply.
- Soft wood trim (no finger-joint or MDF) provided by others.

STANDARD FEATURES

- A40 galvanized steel
- 16-gauge steel

OPTIONS

- A60 galvanized steel
- 18- and 14-gauge steel
- Primer for A40 and A60



Wood trim prep.

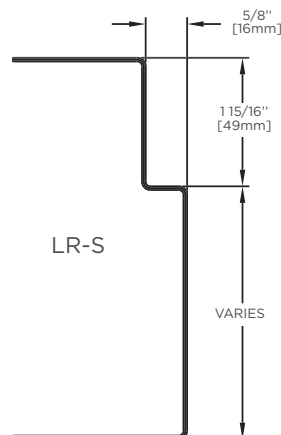
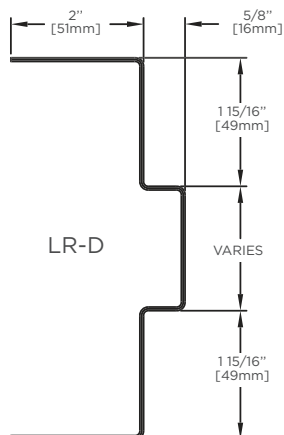

SF SERIES SPLIT FRAME

Designed to be installed after the wall is up. With its unique anchoring system, this frame will save time and coordination on the jobsite in addition to offering a solid and strong face welded assembly.

- Solid, strong and secure opening.
- Face-welded commercial 2-piece welded frame, installed after walls are erected.
- State-of-the-art anchoring system for steel or wood stud walls without face screws.
- Powder-coated pre-finishing from the factory recommended.
- Available for three-sided, transom, borrowed lite and sidelite frame configuration.
- Reduces coordination and time spent on the jobsite.

FIRE RATING

- Available up to 1 ½ hour with ITS/WHI label. Limitations apply.

STANDARD FEATURES

- A40 galvanized steel
- 16-gauge steel

OPTIONS

- A60 galvanized steel
- Primer for A40 and A60

Please consult our website for installation procedure and video.

See page 31 for more details and features.



Split frame wrapping steel stud with drywall.



Split frame anchor (SFA).

FRAME OPTIONS

DOUBLE EGRESS PROFILE

Specialized frame designed for door leaves operating in opposite directions.

- Double egress frame is available in SR, DR and DW series.
- Standard DE profiles:
 - DE2 (default) : 1-3/8" x 2-5/8" (1-3/8" x 2" head)
 - DE1 (N/C): 2" x 3-1/4" (2" x 2-5/8" head)
 - DE3 (N/C): 1-3/8" x 2-5/8" (2" x 2-5/8" head)
- Compatible with all of our standard anchors.
- 16- or 14- or 12 -gauge steel



Special profile available for swing clear hinges or pocket pivot hardware.

THERMAL BREAK PROFILE

Specialized frame designed to significantly reduce condensation or frost on the interior of the frame in cold weather conditions.

- PVC thermal break
- A60 steel recommended
- Not available in KD frame assembly
- Fire rating not available

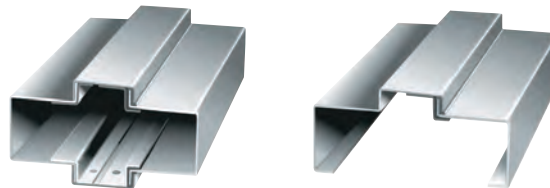

TERMINATED (SANITARY) STOP

Specialized frame option designed to prevent the build-up of germs and bacteria at floor level. It allows for easier floor cleaning in health care settings.

- Available in SR and DR series
- Accepts all of our standard anchors
- 16- or 14-gauge steel
- Variable height available for sanitary stops. Must not exceed 6" in fire-rated openings.
- 45- or 90-degree stop



OTHER PROFILES AVAILABLE

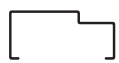

Single rabbet profile.



Centered glass profile.



Caulking groove profile.



Sloped sill profile.



Double stepped ogee profile.



Shadow line profile.

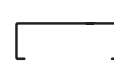

Case open profile.



Kerf frame profile.

NOTE: Call customer service for fire rating availability on these profiles.

CUSTOM FRAME ELEVATIONS



DE LA FONTAINE has developed a true expertise in the assembly of custom frame elevations, including special profiles, arched frames, curved frames, segmented frames or any other special requirements your project may need.

DE LA FONTAINE is your partner of choice when it comes to custom frame elevation.

MATERIAL

- A40, A60, G90, stainless steel 304 and 316 no.4 (satin finish)
- 16-, 14- and 12-gauge

FRAME SERIES

Available in SR, DW, DR, LR and split frame (SF) series

FIRE RATING

- Available up to 3 hour with ITS/WHI label. Limitations apply.

Elevations - Borrowed Lites

SEGMENTED RADIUS BORROWED LITE



Elevations - Arched Frame

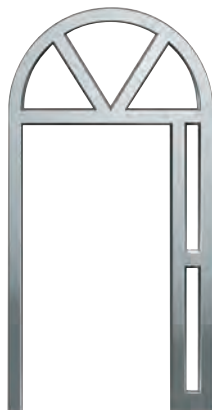

180-minute fire-rated (positive pressure; UL10C).

Elevations - Removable Mullion Details



Head/top of mullion assembly detail.
180-minute fire-rated (positive pressure; UL10C).



Bottom of mullion/floor-assembly detail.
180-minute fire-rated (positive pressure; UL10C).



Fixed mullion floor anchor.

DETENTION PRODUCTS SOLUTIONS

DE LA FONTAINE's detention products deliver **security, performance and durability**. They are ideal for a wide range of applications in correctional centers or other institutions that require a high degree of security.

DOORS

- Galvannealed steel, A40 or A60
- Surface thickness of 16-gauge (1.6 mm) to 12-gauge (2.5 mm)
- Doors of 1-3/4" to 2-1/4"
- 12-gauge reinforced perimeter (14-gauge and 10-gauge also available)
- Welded edges, ground smooth
- Vision kit with welded or screwed glazing bead. Factory installed glass available.
- Integrated acoustic grilles, easy to maintain*
- Heavy duty particle wood or steel stiffened core
- Doors available with powder coating paint, applied in-factory
- Hardware installed in-factory according to project specifications

* The assembly recommended by DE LA FONTAINE allows for the easy removal and reinstallation of vision kits and the acoustic grille.

FRAMES AND SIDELITES

- Galvannealed steel, A40 or A60
- Material available in thicknesses from 14-gauge (2 mm) to 3-gauge (6 mm)
- Continuously welded for a durable, heavy duty assembly
- Multiple profiles available
- Vision kits welded or screwed in-factory, with anti-tamper hardware
- Frames and sidelites available with factory-applied powder coating paint

Our current detention doors and frames are made to the HMMA 863-14 but do not include the ASTM standards.



DOOR MODELS

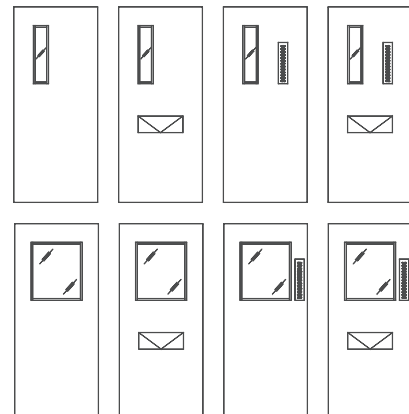

SPLIT FRAME SOLUTIONS

DE LA FONTAINE has combined its expertise, experience and innovation to develop an exclusive welded split frame available in a variety of configurations. Its design features—including a state-of-the-art anchoring system and a 2-piece welded frame—yield an accurate fit with a range of wall conditions and constructions. The result: a solid, strong and secure opening.

**REDUCES
JOBSITE
COORDINATION
AND TIME.**

BENEFITS

Distributors:

- The frame, door and hardware can be assembled before shipping to the jobsite to ensure functionality of the opening.
- Fewer trips to the jobsite.
- Adjustability suitable for retrofit application.

End Users:

- Durable opening with less maintenance.
- Ease of compliance with the annual fire door inspection

Architects:

- Factory powder coated prefinished products.
- No VOCs.

Contractors:

- Installation can start once the walls have been painted.
- Factory prefinishing considerably reduces coordination and time spent on the jobsite.
- One sole responsibility for the complete opening.

Prefinish

- High quality and durable powder coating that exceeds ANSI A250.3.
- Standard and custom colors available.

Fire Rating

- 60-minute or 90-minute (positive pressure; UL10C). Maximum overall dimensions: 10'9"W x 8'2-1/2"H (3277 mm x 2502 mm).
- Pair of doors and field splice approved.

Performance

Exceeds American National Standards Institute ANSI/SDI A250.4, achieves 3,000,000 cycles (Class A).

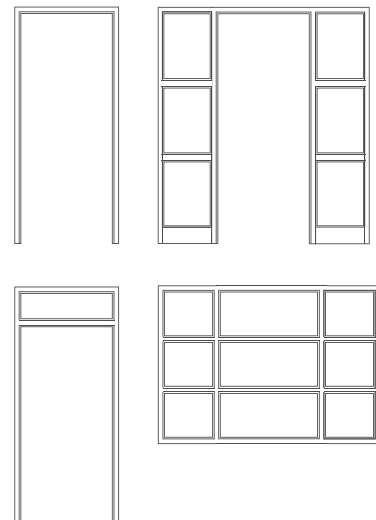

ENERGY EFFICIENT OPENINGS SOLUTIONS

Experts agree that as design and development continue to trend towards energy-efficient performance, operating costs and carbon footprints will decrease. The outer envelope is the key to an eco-friendly building, and by their nature, windows and doors represent an important part of the equation.

The insulation level of our openings is tested as per SDI-113 Standard Practice for Determining the Steady-State Thermal Transmittance of Steel Door & Frame Assemblies. Calculation per the CTS method described in ASTM C1199.

DE LA FONTAINE offers insulating doors that, when combined with a thermal break frame, contribute to a considerable reduction in a building's energy costs.

The thermal break frame is a special profile with a polyvinyl chloride (PVC) seal that inhibits the transfer of heat/cold from the exposed to the non-exposed side of the frame. This seal is also installed in the mullion of elevations and borrowed lites. Mullions can be filled with insulating mineral wool.

Please refer to our individual Door Series or to the technical data sheet on our website for complete information on testing procedures and energy values for DE LA FONTAINE products.

SOUND-DEADENING OPENINGS (STC)

Like many other full-service hollow metal companies, DE LA FONTAINE provides STC door assemblies that are tested in compliance with the following ASTM Standards:

ASTM E90 (2016) - Standard Test Method for Laboratory Measurement of Airborne Sound Transmission Loss of Building Partitions and Elements.

ASTM E413-16 - Classification for Rating Sound Insulation.

ASTM E1332-16 - Standard Classification for Rating Outdoor-Indoor Sound Attenuation.

ASTM E2235-04 (2012) - Standard Test Method for Determination of Decay Rates for Use in Sound Insulation Test Methods.

We offer openings from STC up to 48. These openings requires specific gasketing items to achieve said STC rating, please contact our Customer Service department or your local DE LA FONTAINE Industries representative for additional details.

STAINLESS STEEL DOORS AND FRAMES SOLUTIONS

DE LA FONTAINE also offers stainless steel solutions for damp areas, areas where high hygiene standards are essential, or areas where corrosive products are in use. Stainless steel is also ideal for high-end projects due to its esthetic appeal.

STAINLESS STEEL PRODUCT KEY FEATURES

- Compliant with ASTM A240/A240M
- 304 or 316, no.4 (satin finish)
- All Door Series available except TR Series
- Continuously welded seamless edge available
- All frame series available
- Sanitary welded corner for clean applications available
- Available up to 3 hours with ITS/WHI label. Limitations apply.
- All hardware and internal reinforcements made of stainless steel

Please consult your sales representative or our customer service team for more information on limitations and fire-rated stainless steel products.



Sanitary Welded Frame Assembly

WINDSTORM-RESISTANT OPENINGS SOLUTIONS

Storms and hurricanes are frequent in certain coastal areas, and construction standards demand high-performance products to ensure the safety of building occupants. DE LA FONTAINE offers a durable door that meets the industry's stringent standards.

WINDSTORM STANDARDS COMPLIANCE

- TAS 201, TAS 202, TAS 203, ASTM E330, ASTM E1886, ASTM E1996;
- Design pressure ± 70 PSF, large missile impact D, outswing and inswing doors.
- Tested to the wind load requirements defined in the International Building Code (IBC), the Florida Building Code (FBC), and approval by the Florida Building Commission for High-Velocity-Hurricane-Zone (HVHZ) under FL#46851. Products have been certified by Intertek Testing Services.

SPECIFICATIONS

- Single door: up to 4'0" x 8'0" (914 mm x 2438 mm)
- Pair of doors: up to 6'0" x 8'0" (1829 mm x 2438 mm)
- Minimum 18-gauge door with PA edge seam (HC, PS, PU, STPS, STPU series)
- Minimum 16-gauge frame with 5 $\frac{3}{4}$ jamb depth (SR, DR, DW series)
- Fire-rated up to 1 $\frac{1}{2}$ hour with ITS/WHI label.

See our *Hurricane Door and Frame Assemblies* brochure for limitations.

A FEW OF OUR MANY PROJECTS...



APARTMENTS

The Falls at Flint Hill (VA, USA)
The Avalon (NY, USA)

COMMERCIAL AND OFFICE BUILDINGS

The Prudential Center (MA, USA)
The Loudoun Digital Realty (VA, USA)

EDUCATION AND CULTURE

- Harvard University (MA, USA)
- 3** Hudson Hall, Plattsburg State University of New York (NY, USA)
 - 6** The Boston Museum of Fine Arts (MA, USA)
The University of Pennsylvania (PA, USA)
The John Adams Building and the Library of Congress (DC, USA)
The Academy for Performing Arts (Hong Kong, China)
Thompson Estates Elementary School (MD, USA)

GOVERNMENT AND SECURITY

- The Marcy Correctional Center (NY, USA)
The United States Embassy (Bangkok, Thailand)
The Police Headquarters (Hong Kong, China)
The United States Consulate (Naha, Japan)
The Federal Reserve Board (DC, USA)
- 4** The Illinois State Building (IL, USA)
The Renovated Sections of the Pentagon (DC, USA)
The Columbia County Courthouse (NY, USA)
The Commonwealth of Massachusetts Military Division and Joint Force Headquarters of the Massachusetts National Guard (MA, USA)
One Town Center, ISCIS HQ.(MD, USA)

HEALTH SECTOR

- 1** Glendale Nursing Home (NY, USA)
- 2** The Brigham and Women's Hospital, Carl J. and Ruth Shapiro Cardiovascular Center (MA, USA)
The Massachusetts General Hospital (MA, USA)
The Hospital Maternidad Ciudad de la Salud (Dominican Republic)
The Christiana Care Wilmington Hospital (DE, USA)

You know that DE LA FONTAINE is not just a manufacturer. We are visionaries, inventors and designers. We do not produce doors on an assembly line, but rather create hospital doors that comfort and school doors that protect; office doors that work hard and prison doors that isolate; hotel doors that welcome and residence doors that open up onto life, peace and harmony.

And it is with this approach, one which embraces the world of our clients, that we have gained the confidence of innovative architects, demanding businesses and prestigious institutions all over the world.

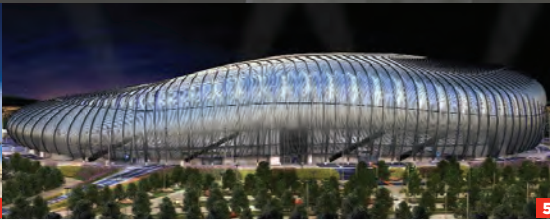

HOTELS AND DORMITORIES

- The Southbridge Hotel & Conference Center (MA, USA)
- The Antaris Suite Hotel (Mexico)
- The Sandy Lane (Barbados)
- The Merrimack College Student Residence (MA, USA)
- The DoubleTree Hotel (PA, USA)

INDUSTRIAL AND PHARMACEUTICAL

- Bayer (CT, USA)
- Merck & Co. (PA, USA)
- Cambridge Isotope Laboratories (MA, USA)
- Pfizer (MA, USA)

SPORT INFRASTRUCTURE

- 5** The Monterrey Stadium (Mexico)
- Colorado State University Stadium (CO, USA)



For complete information on our products, visit our website:

DELAFONTAINE.COM

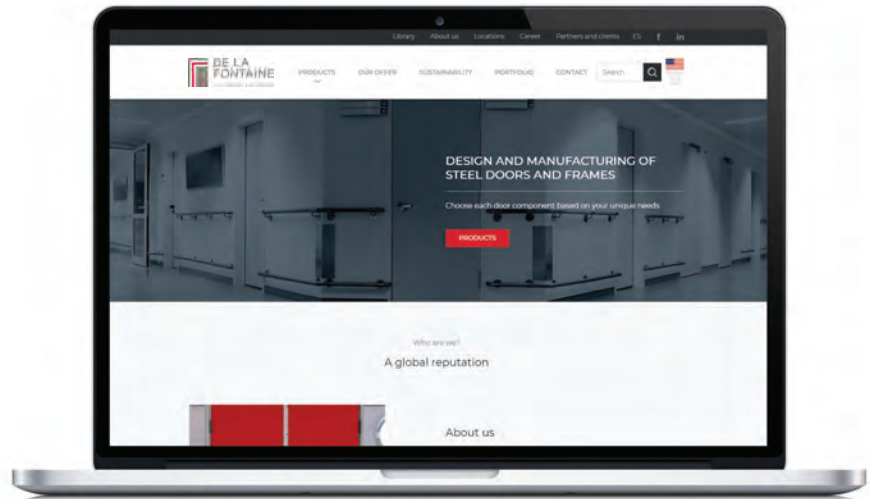

PERSONALIZED CUSTOMER EXPERIENCE, QUALITY PRODUCTS AND ONE-STOP SHOP:

THIS IS THE COMBINAISON THAT MAKES US A TRUE PARTNER.

PHONE

1 800 565-9230

FAX

1 800 965-5928

EMAIL

sales@delafontaine.com

